

October 2008

Ashley Norton

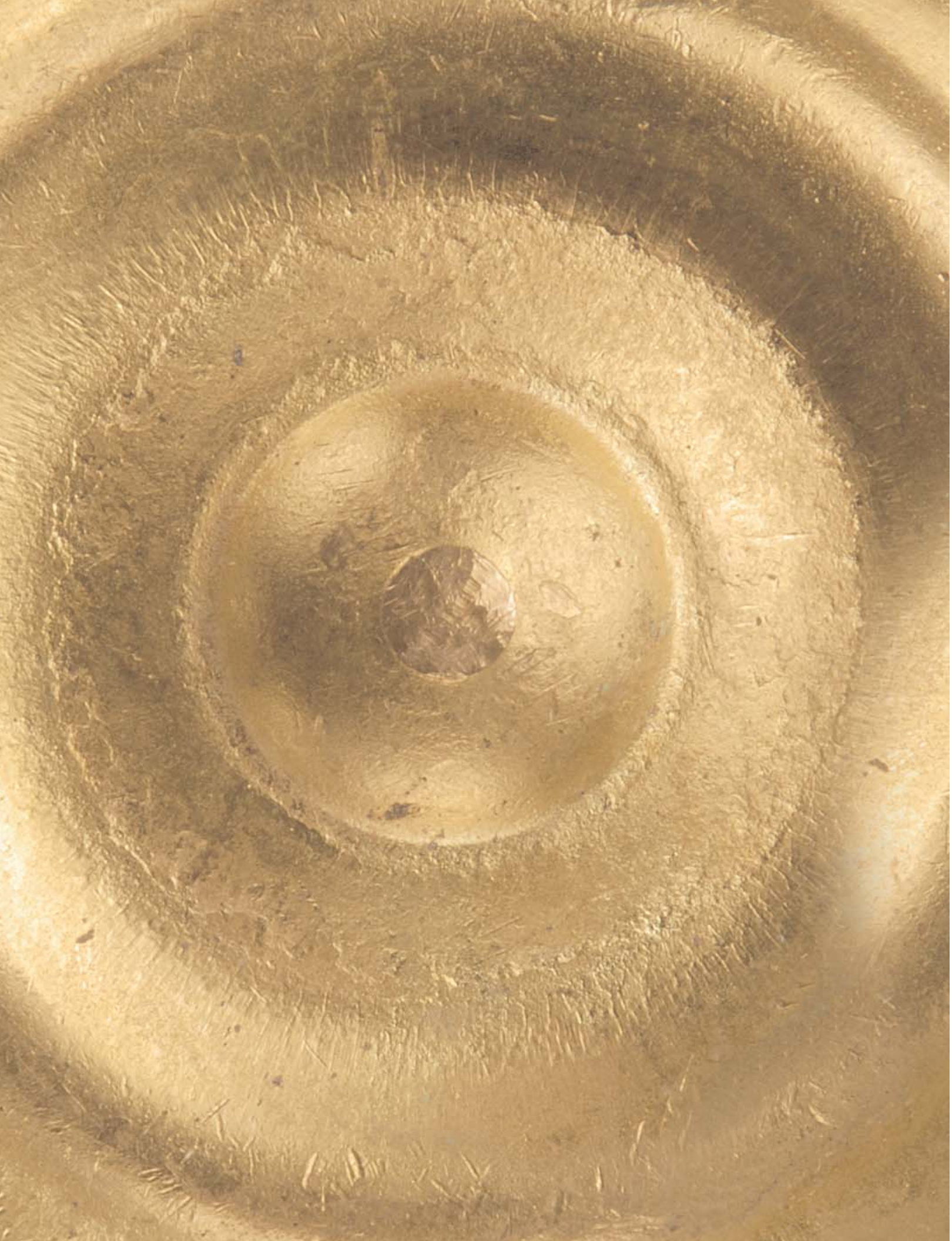



Since 1987, Ashley Norton's premium door hardware has graced the homes of discerning clients and upscale resorts worldwide.

Designed in England, our product range includes a wide selection of contemporary and traditional levers to accommodate almost any architectural style. Some of our designs are influenced by contemporary Italian themes.

Ashley Norton hardware is aesthetically pleasing and good to touch. Backed by the most durable components, Ashley Norton strives to produce the finest quality products time and time again.

Ashley Norton

Ashley Norton



Introduction	
Finishes	4
Suites	5
Ordering Guide	6
Levers & Knobs	
Contemporary Levers	8 - 13
Traditional Levers	14 - 17
Knobs	18
Door Hardware Suites	
Rectangular	19 - 23
Arched	24 - 30
Traditional Round & Oval	31 - 33
Contemporary	34 - 35
Entry Hardware	
Deadbolts	37
Tubular Entry	38 - 41
Mortise Entry	42 - 45
Multipoint Trim	46 - 51
Sliding Door Hardware	52 - 53
Accessories	54
Warranty	54
Summary of Dimensions	54

Our Finishes

Ashley Norton

Standard



.4 Satin Nickel

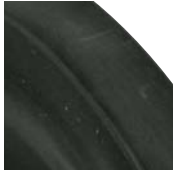

.8 Dark Oil Rubbed

Our numerous finishes allow our clients to express individuality. From trendy polished nickel to a more traditional satin nickel or oil rubbed bronze... the choice is yours.

Dark and light oil rubbed bronze are dynamic. These "living" surfaces will take on unique hues as age, climate and touch work their charm, creating an ever-changing patina.

Our standard finishes are dark oil rubbed (.8) and satin nickel (.4). Seven additional finishes are custom manufactured to order.

The photos shown in this brochure give a close representation of the true appearance of these finishes, but a visit to a local dealer will allow you to appreciate the true appearance and feel of our hardware.

Custom



.2 Satin Chrome



.9 Polished Chrome



.4B Polished Nickel



.7 Pewter

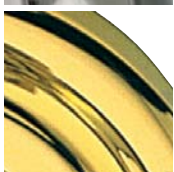

.3 Polished Brass

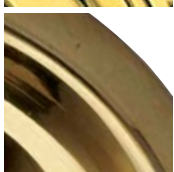

.3U Unlacquered Brass



.6 Light Oil Rubbed

Please note that products ordered in our custom finishes are manufactured to order.

GUIDE TO FINISH CODES

US	BHMA	ASHLEY	FINISH
26D	626	2	Satin Chrome
3	605	3	Polished Brass
3NL	605NL	3U	Unlacquered Brass
15	619	4	Satin Nickel
14	618	4B	Polished Nickel
~	~	6	Light Oil Rubbed
15A	620	7	Pewter
10B	613	8	Dark Oil Rubbed
26	625	9	Polished Chrome

Our Suites

Ashley Norton

Rectangular Suite



Arched Suite



Contemporary Suite



Traditional Rose & Oval



Almost any combination of lever, escutcheon and finish may be combined to create a unique piece for your project. See inside back cover for further technical information relating to ordering Ashley Norton hardware.

CODE CONSTRUCTION

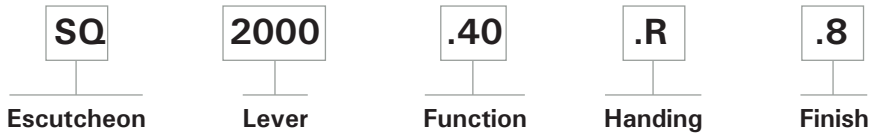

Handing is required for single dummies and all entry hardware. Our interior passage and privacy sets do not require handing, except if ordered with the 'AR' escutcheon.

To designate a split finish indicate the exterior finish first then the interior finish. For example .8/4 designates dark oil rubbed outside with satin nickel inside. Any split finish combination is considered custom.

HANDING GUIDE FOR SWINGING DOOR HARDWARE

- L** = Left Handed
- R** = Right Handed
- LHR** = Left Hand Reverse (mortise lock only)
- RHR** = Right Hand Reverse (mortise lock only)

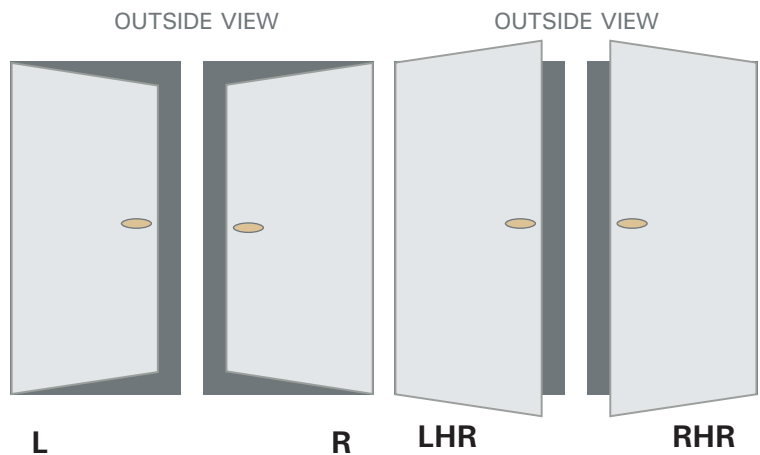
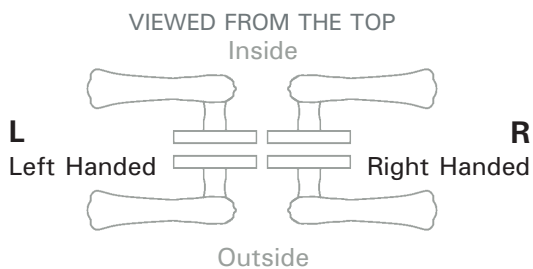

GUIDE TO INTERIOR FUNCTIONS

Privacy - 20 Function

A locking set with operable handles. Door locked by a push pin from the inside and can be unlocked by inserting a pointed object from the outside.

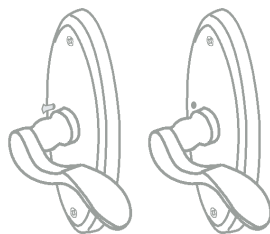

Passage - 30 Function

A non-locking set with operable handles on both sides.

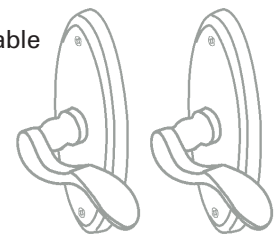

Single Dummy - 40 Function

Inoperable handle on one side of door.



Full Dummy - 42 Function

Inoperable handles both sides of door.

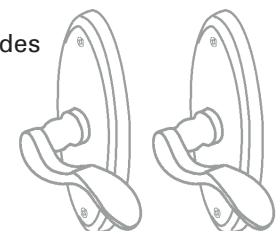

Levers

Ashley Norton

Contemporary	8 - 13
Traditional	14 - 17
Knobs	18



Levers

Ashley Norton

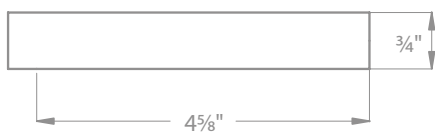

Meridian – 3100 Series

Shown on RE square rose

Shown in Satin Nickel

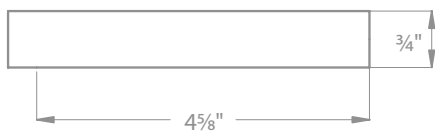

Meridian – 3100 Series

Shown on AN round rose

Shown in Satin Nickel

Levers

Ashley Norton

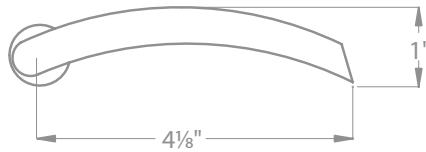
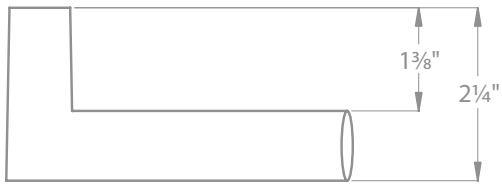

Centaur – 3490 Series
Recommended with AN round rose

Shown in Satin Chrome



Atlas – 3750 Series
Recommended with AN round rose

Shown in Satin Nickel

Levers

Ashley Norton

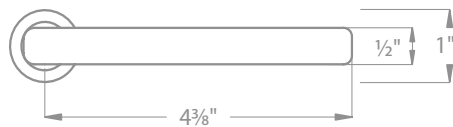
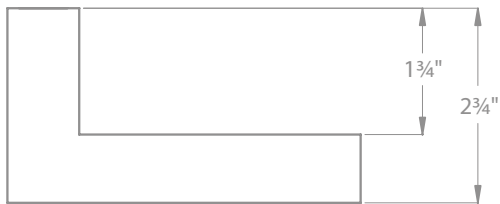

Apollo – 450 Series

Recommended with AN round rose

Shown in Satin Nickel

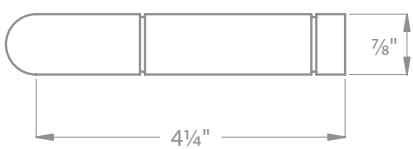

Myron – 6300 Series

Recommended with AN round rose

Shown in Satin Nickel

Levers

Ashley Norton

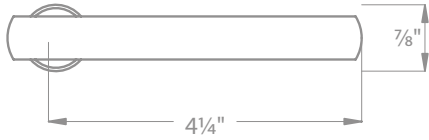
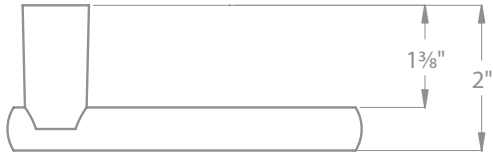

Challenger – 6000 Series

Recommended with AN round rose

Shown in Polished Chrome

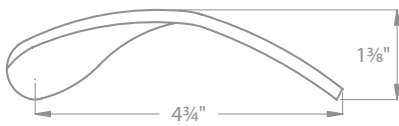

Volo – 1951 Series

Recommended with AN round rose

Shown in Polished Chrome

Levers

Ashley Norton

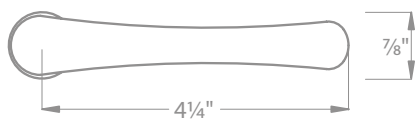

Elios – 5300 Series

Recommended with AN round rose

Shown in Satin Nickel

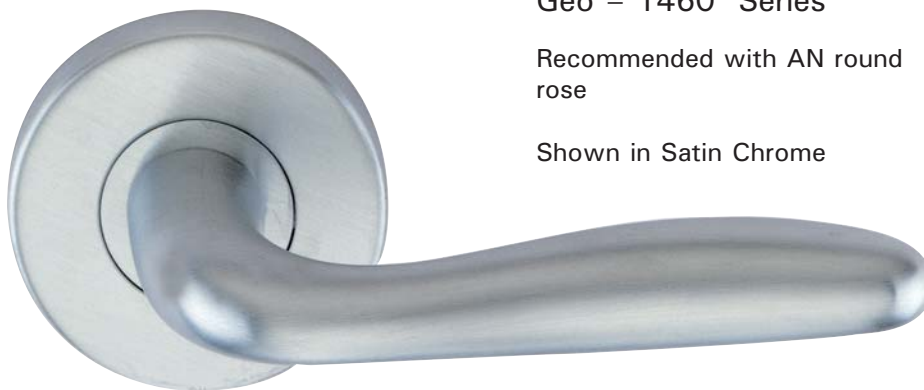
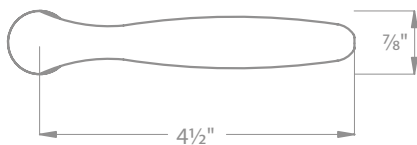

Geo – 1460 Series

Recommended with AN round rose

Shown in Satin Chrome

Levers

Ashley Norton

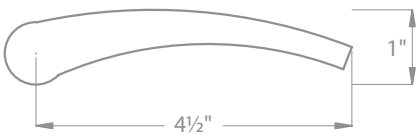
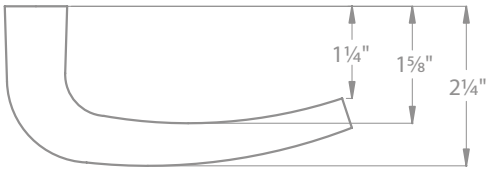

Wing – 1121 Series

Recommended with AN round rose

Shown in Satin Chrome

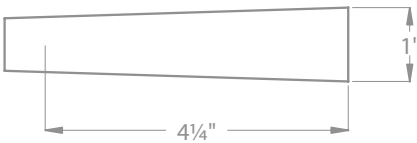
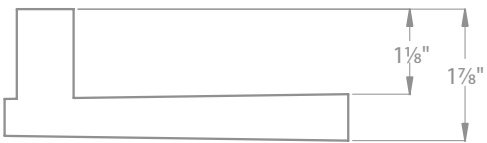

Adelpia – 2590 Series

Recommended with AN round rose

Shown in Satin Chrome

Levers

Ashley Norton

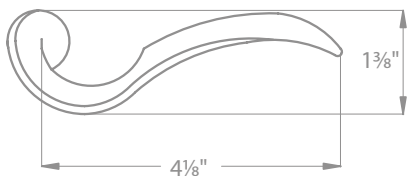
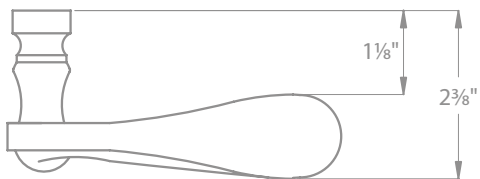

Chesterfield - 1700 Series

Recommended with TA round rose or choice of escutcheon

Shown in Satin Nickel

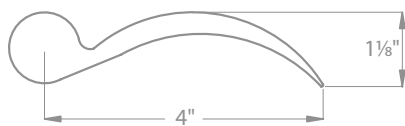

Churchill - 500 Series

Recommended with TA round rose or choice of escutcheon

Shown in Satin Nickel

Levers

Ashley Norton

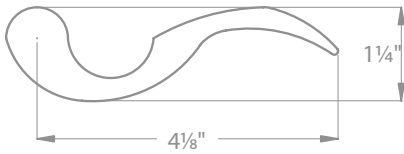
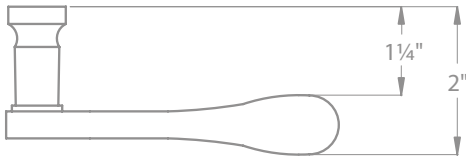

Chester - 2000 Series

Recommended with TA round rose or choice of escutcheon

Shown in Satin Nickel

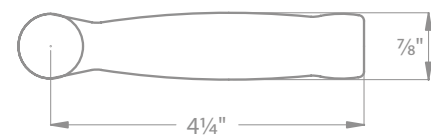
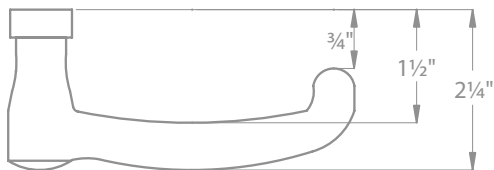

Hampton - 400 Series

Recommended with AN round rose or choice of escutcheon

Shown in Satin Nickel

Levers

Ashley Norton

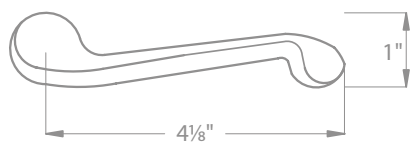

Shropshire – 800 Series

Recommended with TA round rose or choice of escutcheon

Shown in Satin Nickel

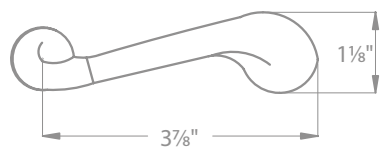

Chiltern – 1600 Series

Recommended with TA round rose or choice of escutcheon

Shown in Light Oil Rubbed

Levers

Ashley Norton

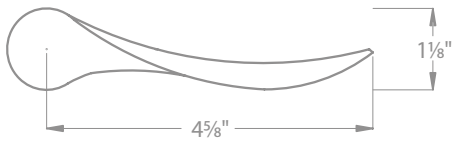
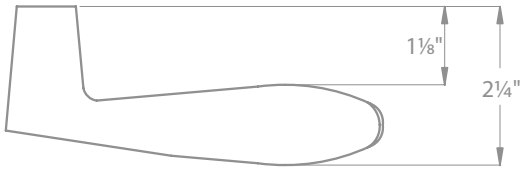

Vallea – 1910 Series

Recommended with TA round rose or choice of escutcheon

Shown in Satin Nickel

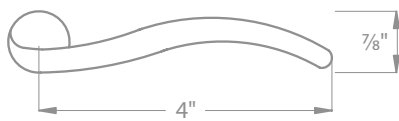

Everest – 7100 Series

Recommended with AN round rose or choice of escutcheon

Shown in Satin Nickel

Knobs

Ashley Norton

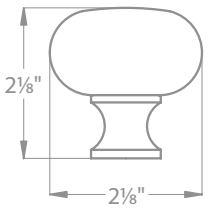
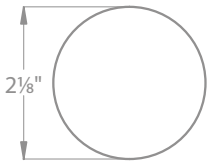

Windsor – 900 Series

Recommended with choice of escutcheon

Shown in Dark Oil Rubbed

Windsor knob is not available with AN, TA or AR rose

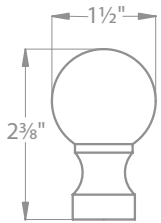
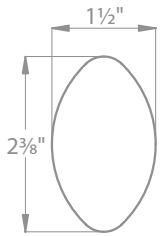

Carlisle – 6600 Series

Recommended with choice of escutcheon

Shown in Satin Nickel

Carlisle knob is not available with AN or TA rose

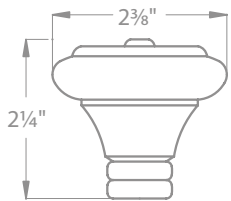
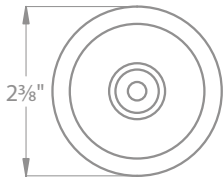

Ascot – 9200 Series

Recommended with choice of escutcheon

Shown in Light Oil Rubbed

Ascot knob is not available with AN, TA or AR rose

Rectangular Suite

Ashley Norton



Rectangular Suite - Interior

Ashley Norton

The 5 x 2 1/2" SQ escutcheon is ideal for interior application, available with any lever or knob in your choice of finish.



SQ Escutcheon
5 x 2 1/2"
Shown with Churchill lever
(500) in Dark Oil Rubbed



SQ Escutcheon
5 x 2 1/2"
Shown with Hampton lever
(400) in Dark Oil Rubbed



SQ Escutcheon
5 x 2 1/2"
Shown with Carlisle knob
(6600) in Satin Nickel



SQ Escutcheon
5 x 2 1/2"
Shown with Windsor knob
(900) in Polished Brass

Rectangular Suite - Interior

Ashley Norton

The grand 11 x 2 1/2" SE escutcheon is ideal for larger interior doors and available with any lever or knob in your choice of finish.



SE Escutcheon
11 x 2 1/2"
Shown with Ascot knob
(9200) in Satin Nickel



SE Escutcheon
11 x 2 1/2"
Shown with Hampton lever
(400) in Light Oil Rubbed

Rectangular Suite - Tubular Entry

Ashley Norton



SQTB Escutcheon
Shown with Chesterfield
lever (1700) in
Dark Oil Rubbed



SOES Escutcheon
Shown with Chiltern
lever (1600) in
Dark Oil Rubbed



DB4150 Deadbolt
Shown in Satin Nickel



SQMR Escutcheon
Shown with Chesterfield
lever (1700) in
Satin Nickel



SQML Escutcheon
Shown with Volo
lever (1951) in
Polished Chrome



NP3 Escutcheon

Shown with Churchill lever
(500) in Dark Oil Rubbed



CB3 Escutcheon

Shown with Centaur lever
(3490) in Polished Chrome



NMW Escutcheon

Shown with Hampton lever
(400) in Satin Nickel



SQQD Escutcheon

Shown with offset Hampton
pull in Light Oil Rubbed

Arched Suite

Ashley Norton



Arched Suite - Interior

Ashley Norton

The 7 x 2 1/2" SR escutcheon is ideal for interior application, available with any lever or knob in your choice of finish.



SR Escutcheon
7 x 2 1/2"
Shown with Chesterfield lever
(1700) in Dark Oil Rubbed



SR Escutcheon
7 x 2 1/2"
Shown with Churchill lever
(500) in Dark Oil Rubbed



SR Escutcheon
7 x 2 1/2"
Shown with Chiltern lever
(1600) in Satin Nickel



SR Escutcheon
7 x 2 1/2"
Shown with Ascot knob
(9200) in Light Oil Rubbed

Arched Suite - Interior

Ashley Norton

The $2\frac{3}{8}$ x $2\frac{1}{4}$ " AR escutcheon is suited for interior application, available with any lever or Carlisle knob in your choice of finish.



AR Escutcheon

$2\frac{3}{8}$ x $2\frac{1}{4}$ "

Shown with Chester lever
(2000) in Satin Nickel



AR Escutcheon

$2\frac{3}{8}$ x $2\frac{1}{4}$ "

Shown with Carlisle knob
(6600) in Light Oil Rubbed

Arched Suite - Tubular Entry

Ashley Norton



SPTB Escutcheon

Shown with Churchill
lever (500) in
Satin Nickel



SPES Escutcheon

Shown with Churchill
lever (500) in
Satin Nickel



DB4165

Shown in Light Oil Rubbed



SPMR Escutcheon
Shown with Windsor knob (900) in Dark Oil Rubbed



SPML Escutcheon
Shown with Carlisle knob (6600) in Satin Nickel

Arched Suite - Multipoint Hardware

Ashley Norton



SP3 Escutcheon

Shown with Chester lever
(2000) in Satin Nickel



AB3 Escutcheon

Shown with Shropshire lever
(800) in Dark Oil Rubbed



SMW Escutcheon

Shown with Chesterfield lever
(1700) in Light Oil Rubbed



SHP Escutcheon

Shown with offset Hampton
pull in Dark Oil Rubbed

Traditional Rose & Oval

Ashley Norton



Traditional Rose & Oval

Ashley Norton

The 2³/₈" diameter TA traditional rose is ideal for interior application, available with any lever in your choice of finish. Featuring concealed screws on both sides of door, the TA rose complements almost all of our traditional levers.



TA Traditional Rose
2³/₈" diameter
Shown with Chesterfield lever
(1700) in Satin Nickel



TA Traditional Rose
2³/₈" diameter
Shown with Vallea lever
(1910) in Satin Nickel



TA Traditional Rose
2³/₈" diameter
Shown with Chiltern lever
(1600) in Light Oil Rubbed



TA Traditional Rose
2³/₈" diameter
Shown with Churchill lever
(500) in Dark Oil Rubbed



DB4100
Shown in Polished Brass



DB4190
Shown in Dark Oil Rubbed

Traditional Rose & Oval

Ashley Norton

The 5 x 2 1/2" OV escutcheon is ideal for interior application, available with any lever or knob in your choice of finish.



OV Escutcheon
5 x 2 1/2"
Shown with Chester lever
(2000) in Polished Nickel



OV Escutcheon
5 x 2 1/2"
Shown with Chesterfield lever
(1700) in Polished Brass



OV Escutcheon
5 x 2 1/2"
Shown with Chiltern lever
(1600) in Light Oil Rubbed



DB4140
Oval deadbolt
Shown in Polished Nickel



Contemporary Suite

Ashley Norton

The 2³/₈ diameter AN round rose and 2¹/₂" RE square rose are ideal for interior application, available with any lever in your choice of finish. Featuring concealed screws on both sides of door, these roses complement our contemporary levers.

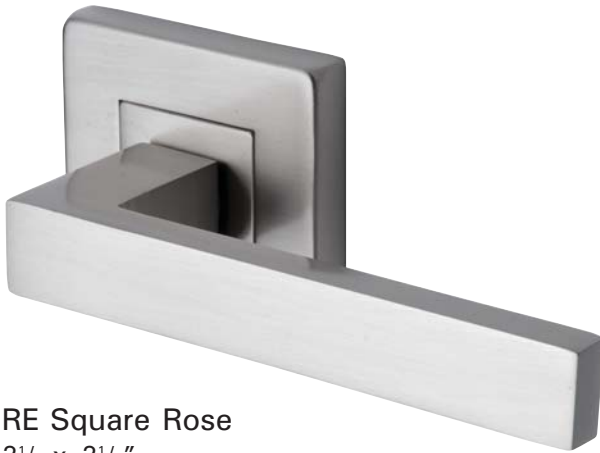

RE Square Rose
2¹/₂ x 2¹/₂"
Shown with Meridian lever
(3100) in Satin Nickel

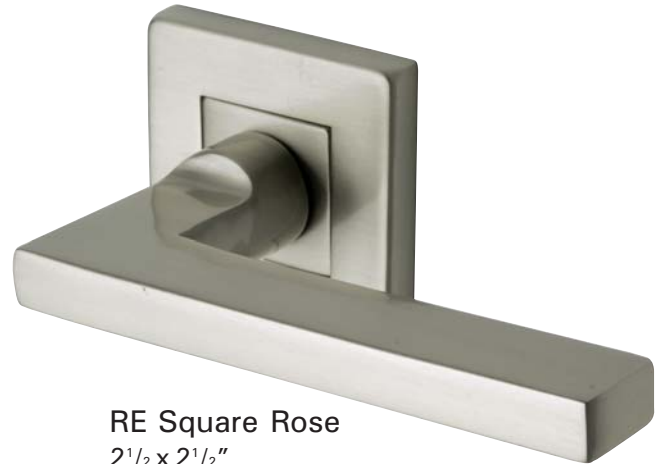

RE Square Rose
2¹/₂ x 2¹/₂"
Shown with Apollo lever
(450) in Satin Nickel



AN Rose
2³/₈" diameter
Shown with Challenger lever
(6000) in Polished Chrome



AN Rose
2³/₈" diameter
Shown with Centaur lever
(3490) in Polished Chrome



DB4130
Shown in Satin Nickel



DB4120
Shown in Satin Chrome



Deadbolts

Deadbolts are available in keyed, double-keyed or patio function

Ashley Norton



DB4100 Round deadbolt
2 1/2" diameter
Shown in Polished Brass



DB4140 Oval deadbolt
3 1/8" x 2 1/2"
Shown in Polished Nickel



DB4190 Traditional Round Deadbolt
2 1/2" diameter
Shown in Dark Oil Rubbed



DB4165 Arched Deadbolt
4" x 2 1/2"
Shown in Dark Oil Rubbed



DB4120 Contemporary Round Deadbolt
2 1/2" diameter
Shown in Satin Chrome



DB4150 Rectangular Deadbolt
3" x 2 1/2"
Shown in Satin Nickel



DB4130 Contemporary Square Deadbolt
2 1/2" x 2 1/2"
Shown in Polished Chrome

Lever by Lever Tubular Entry Sets

Ashley Norton

ORDERING GUIDE

SPES	1700	.50	.R	.4
Plate	Lever	Function	Hand	Finish

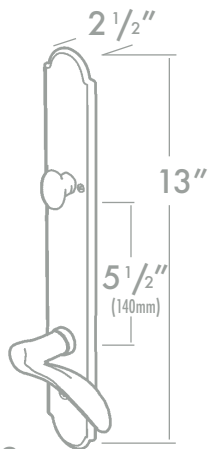

SPES

SPES Escutcheon

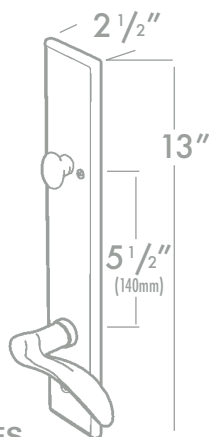

SQES

Shown with Churchill lever (500) in Satin Nickel



Inside Outside

Entry .50

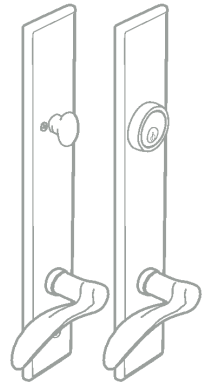

Full Dummy .42

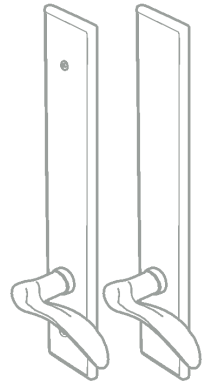

Patio .43

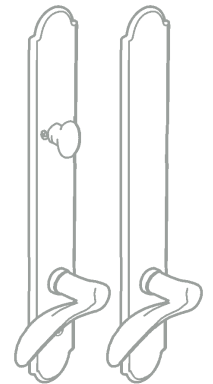

Double Entry .52

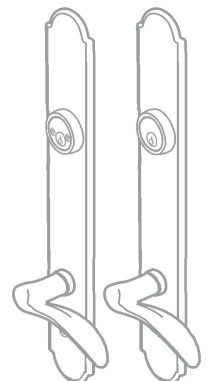

SQES Escutcheon

Shown with
Chiltern lever (1600)
in Dark Oil Rubbed



Tubular Gripsets

ORDERING GUIDE

SPTB	500	.50	.L	.8
Plate	Lever	Function	Hand	Finish

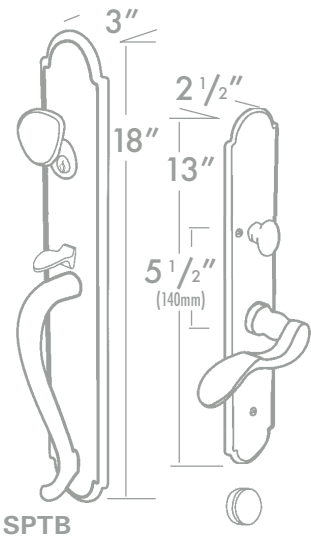

SPTB Escutcheon

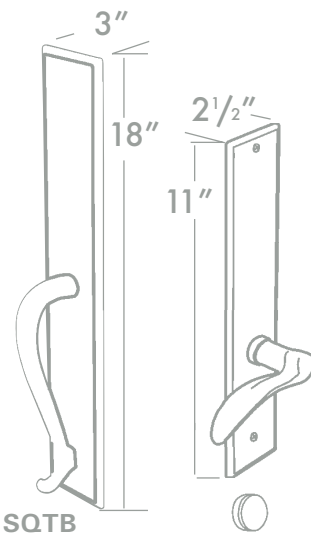

Shown with Churchill lever (500) in Satin Nickel



Outside Inside

Entry .50

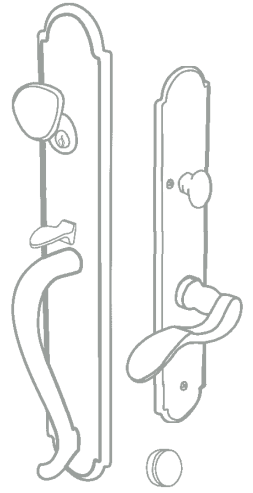

Full Dummy .42

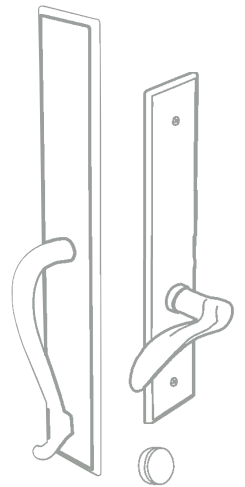

SQTB Escutcheon

Shown with
Chesterfield lever (1700)
in Dark Oil Rubbed



Lever by Lever Mortise Entry Sets

Ashley Norton

ORDERING GUIDE

SPML	6600	.12	.R	.4
Plate	Lever	Function	Hand	Finish

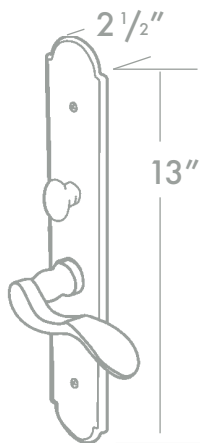

SPML

SPML Escutcheon

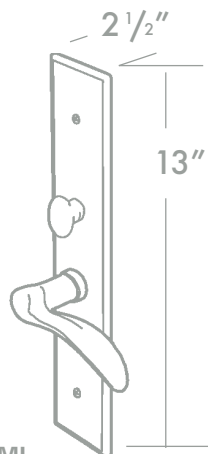

SQML

Shown with
Carlisle knob (6600)
in Satin Nickel



Inside Outside

Entry .12

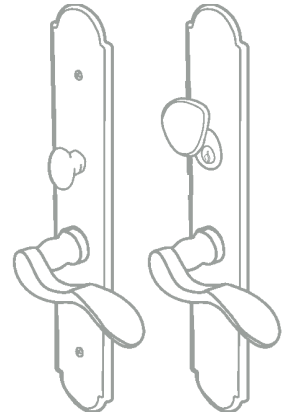

Full Dummy .22

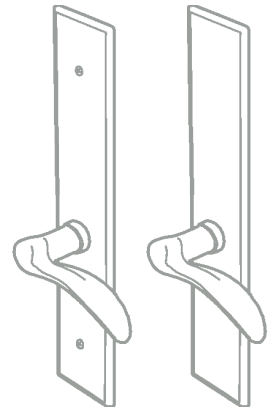

SQML Escutcheon

Shown with
Volo lever (1951)
in Polished Chrome



A full range of commercial functions is available for project orders. Please enquire for details.

Mortise Gripsets

ORDERING GUIDE

SPMR	900	.10	.R	.8
Plate	Lever	Function	Hand	Finish

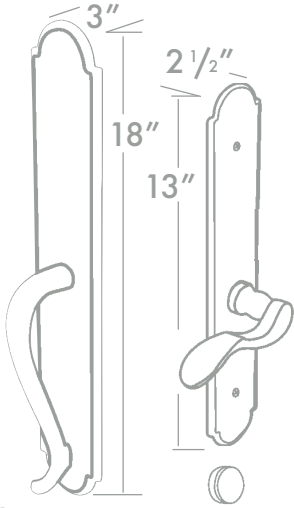

SPMR

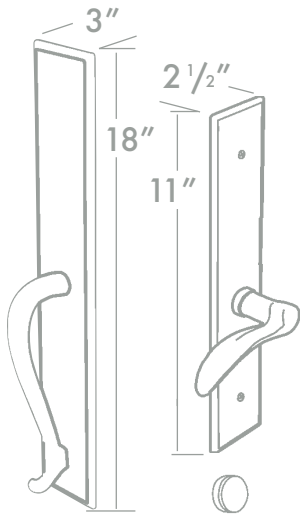

SQMR

SPMR Escutcheon

Shown with Windsor knob (900) in Dark Oil Rubbed



Outside Inside

Entry .10

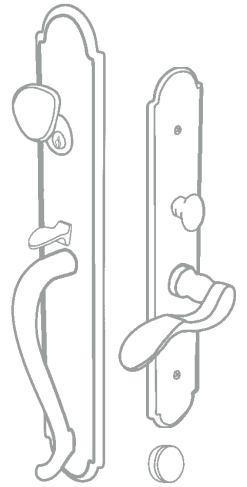

Full Dummy .42

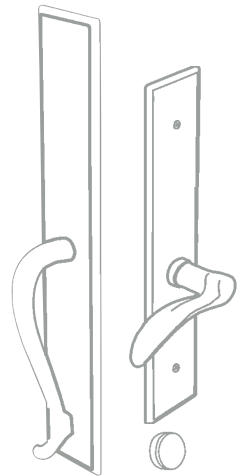

SQMR Escutcheon

Shown with
Chesterfield lever (1700)
in Satin Nickel



Multi-Point Trim for G-U Locks



Multi-Point Locks are unsuitable for use with knobs.

ORDERING GUIDE				
NP3	500	.55	.L	.8
Plate	Lever	Function	Hand	Finish

Multipoint trim with 92mm center-to-center between lever and American cylinder.

Suitable for doors using G-U or similar locks with 92mm distance between lever and American tailpiece. For Ashland locks, see pages 50 - 51.

For further details refer to www.ashleynorton.com/multipoint/

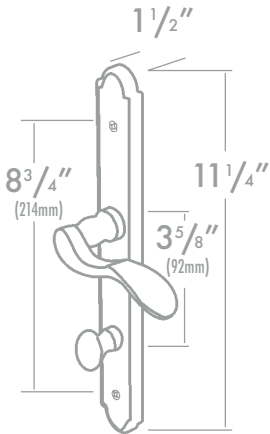

SP3

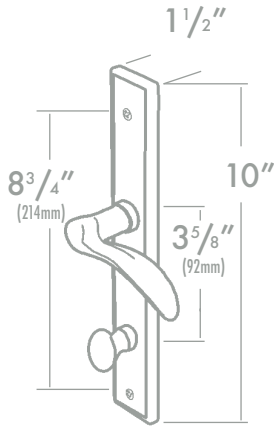

NP3

NP3 Escutcheon

Shown with Churchill lever (500) in Dark Oil Rubbed

Wide Escutcheon Option

The full range is also available in a wide escutcheon option.



SP5

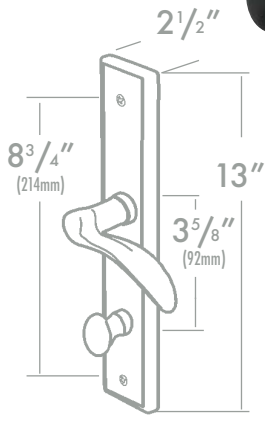

NP5

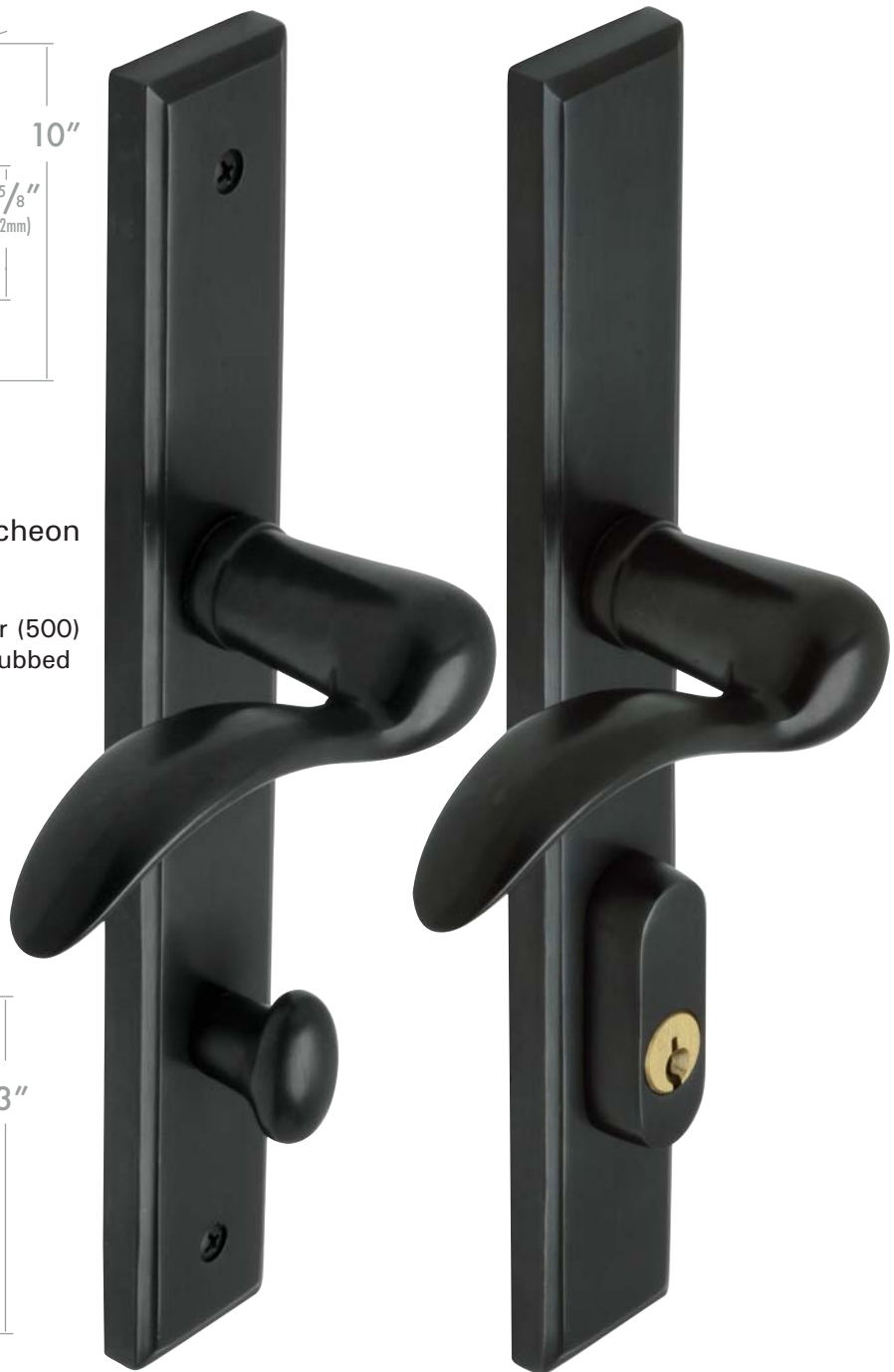

Inside Outside

Entry .55

Keyed with American Cylinder

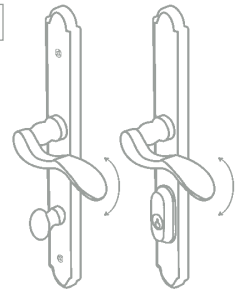

Patio .53

Non-keyed, American style thumbturn inside

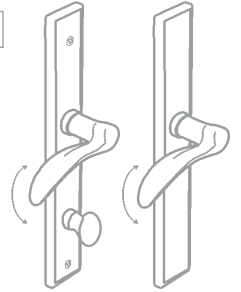

Full Dummy .42

Lever high full dummy for inactive door.

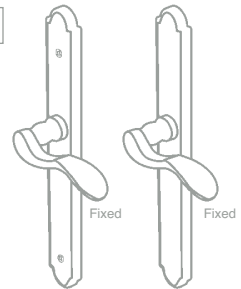

Lever Low Dummy .47

Lever low full dummy for inactive door.
For Eagle and Hurd doors only

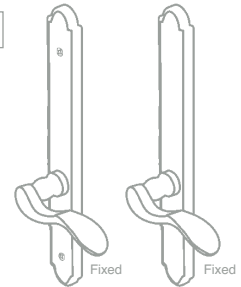

Passive .39

Non-keyed. Both levers free to rotate
For interior use only



Half Passive .38

Non-keyed. Fixed lever outside, operating lever inside

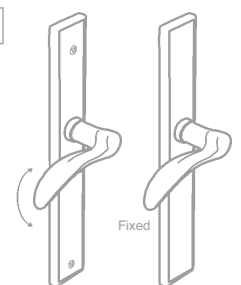

SP3 Escutcheon

Shown with Chester lever (2000) in Satin Nickel



Multi-Point Trim for Hoppe Locks



Multi-Point Locks are unsuitable for use with knobs.

ORDERING GUIDE				
CB3	3490	.58	.L	.9
Plate	Lever	Function	Hand	Finish

Multipoint trim with 92mm center-to-center between lever and Profile cylinder.

Suitable for doors using Hoppe or similar locks with 92mm distance between lever and Profile cylinder.

For further details refer to www.ashleynorton.com/multipoint/

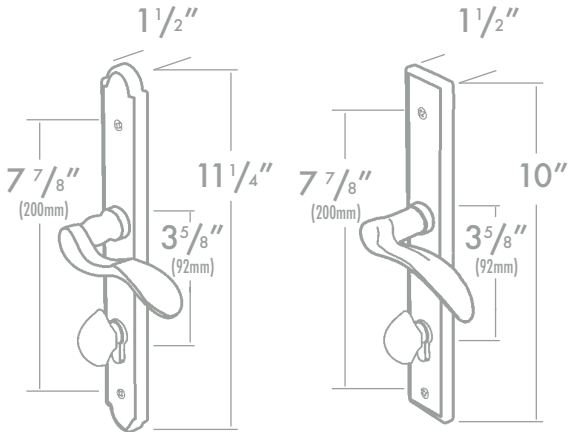

AB3

CB3

CB3 Escutcheon

Shown with Centaur lever (3490) in Polished Chrome



Wide Escutcheon Option

The full range is also available in a wide escutcheon option.

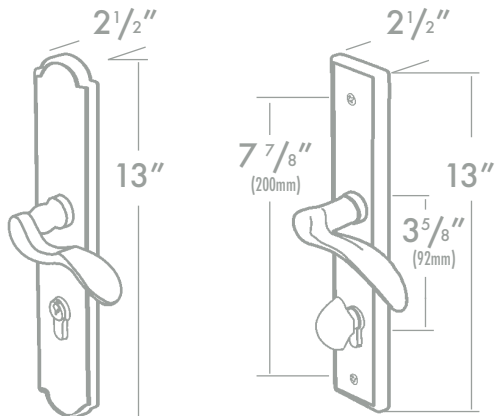

AB5

CB5

Inside Outside

Entry .57

Keyed with Profile Cylinder

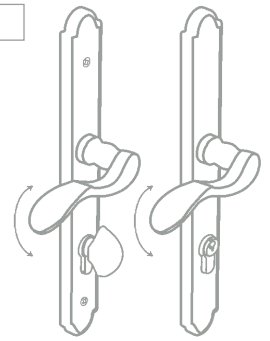

Patio .58

Non-keyed, Profile style thumbturn inside

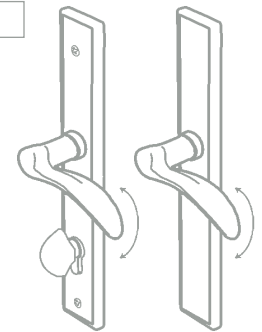

Full Dummy .42

Lever high full dummy for inactive door.

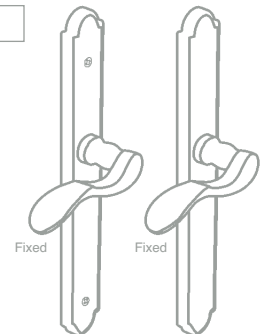

Passive .39

Non-keyed. Both levers free to rotate. For interior use only

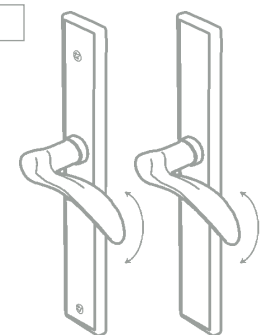

Half Passive .38

Non-keyed. Fixed lever outside, operating lever inside

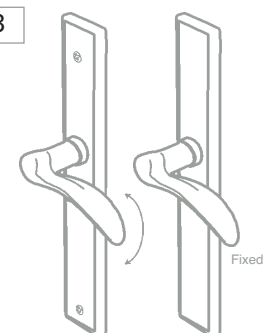

AB3 Escutcheon

With Shropshire lever (800) in Dark Oil Rubbed



Multi-Point Trim for Ashland Locks



Multi-Point Locks are unsuitable for use with knobs.

ORDERING GUIDE				
NMW	400	.53	.L	.4
Plate	Lever	Function	Hand	Finish

Multipoint trim for doors using Ashland locks only.
For trim to suit G-U locks refer to pages 48 - 49.

For further details refer to www.ashleynorton.com/multipoint/

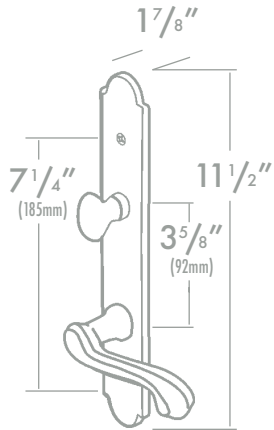

SMW

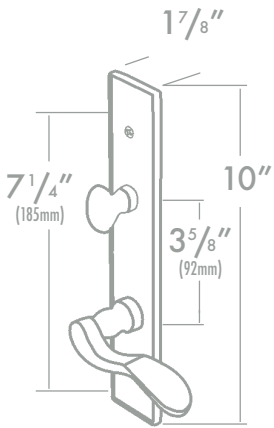

NMW

NMW Escutcheon

Shown with Hampton lever (400) in Satin Nickel



Inside Outside

Entry .55

Keyed with American Cylinder

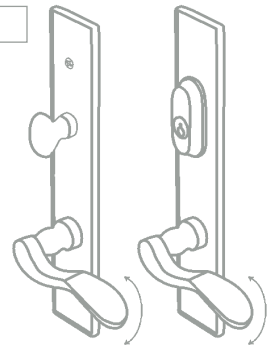

Patio .53

Non-keyed, American style thumbturn inside

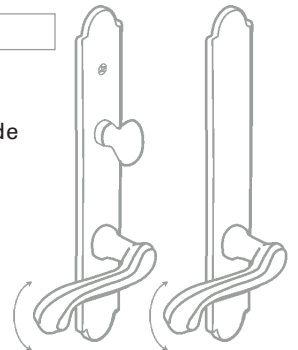

Full Dummy .47

Lever low full dummy for inactive door.

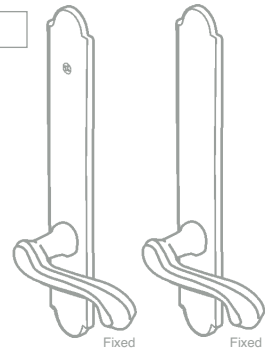

Passive .39

Non-keyed. Both levers free to rotate.

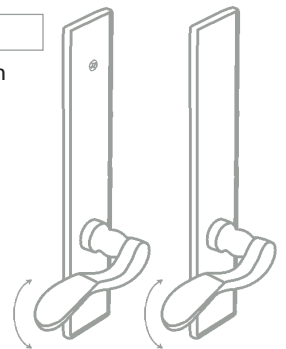

Half Passive .38

Non-keyed. Fixed lever outside, operating lever inside

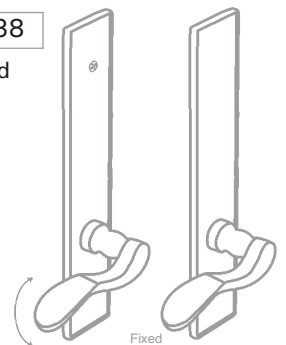

SMW Escutcheon

Shown with Chesterfield lever (1700) in Light Oil Rubbed





C1820 Flush Pull

Available 4x2"
6x2"
Shown in Satin Nickel



C1165 Edge Pull

3 7/8" x 3/4"
Shown in Dark Oil Rubbed



Patio Sliding Door Trim Set
SLDPULL Series

8 3/8" x 1"

Fixed 'D' handles with active turnpiece
Handing not required

Suitable for mortise locks with mounting holes
100mm (3.94") apart. Thumbturn located 31mm
above lower screw position (19mm offset from
center)

Available in keyed, patio and dummy functions

See www.ashleynorton.com/multipoint/ for
further details



Sliding Door Trim with American Cylinder

Fixed levers, active thumbturn

Available for Hoppe HLS 9000 lock and certain Ashland locks.

Available in keyed, patio and full dummy functions.

See www.ashleynorton.com/multipoint/ for further details



Sliding Door Trim with Profile Cylinder

Operating levers (8mm spindle) with profile cylinder
122mm center-to-center (lever to cylinder)

Available in keyed, patio and full dummy functions.

See www.ashleynorton.com/multipoint/ for further details

Accessories

Ashley Norton

Available in satin nickel and dark oil rubbed as standard.
Special finishes subject to minimum order quantities.



C586 Privacy Bolt
1³/₈" diameter
Shown in Satin Nickel



V4043 Privacy Bolt
2¹/₈" diameter
Shown in Polished Chrome



C131 Door Stop
3" length
Shown in Satin Nickel

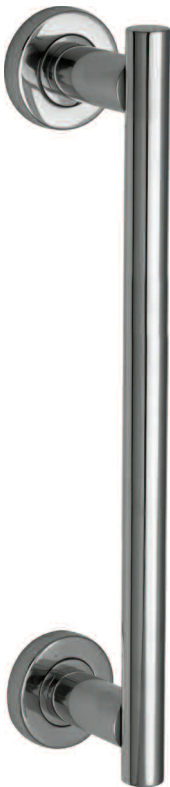

V2057 Pull Handle
11" length
Shown in Polished Chrome



V2056 Pull Handle
9⁵/₈" length
Shown in Polished Chrome



Push Plate
SQ.E.11 11 x 2¹/₂"
SQ.E.18 18 x 3"
Shown in Satin Chrome

Custom sizes available subject
to minimum order quantities

Cabinet Hardware

Ashley Norton

Available in satin nickel and dark oil rubbed as standard.
Special finishes subject to minimum order quantities.



C113
Available 1¹/₄" , 1¹/₂"
Shown in Satin Chrome



C114
Available 1¹/₄" , 1¹/₂"
Shown in Satin Nickel

The above knobs may be combined with any of the backplates below.



FL.CAB Backplate
Length 6⁵/₁₆"
Shown in Satin Nickel



SR.CAB Backplate
2¹/₂ x 1¹/₂"
Shown in Polished Chrome



SQ.CAB Backplate
2¹/₂ x 1¹/₂"
Shown in Dark Oil Rubbed



C371
4³/₄" length, 3³/₄" center-to-center
Shown in Light Oil Rubbed



C376
5" length, 3³/₄" center-to-center
Shown in Polished Chrome



C1700
3³/₄ x 1³/₄"
Shown in Light Oil Rubbed

Mechanical Warranty

Ashley Norton proudly backs our products with a 10-year mechanical warranty to the original residential purchaser, providing the product has been installed in accordance with our installation instructions. Please see our website or your local dealer for full details and terms of our warranties.

Dimensions

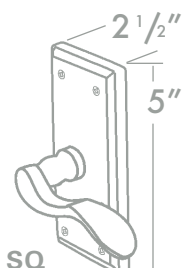
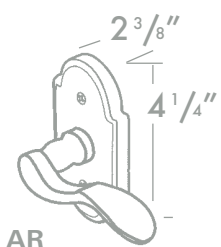
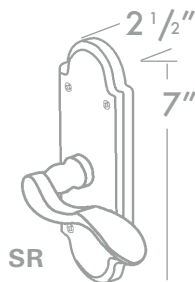
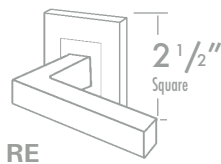
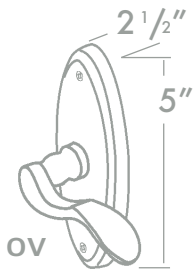
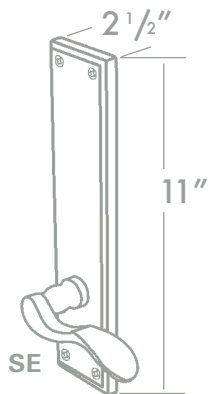
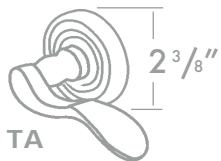

Backset, Strike, Door Thickness

Our hardware is supplied as standard with accessories to suit a typical door. However, a number of options are available to suit particular circumstances.

Backset (Tubular Latchsets and Deadbolts)

- Standard - 2 3/8"
- Option - 2 3/4"

Backset (Mortise Locks)

- Standard - 2 1/2"
- Option - 2 3/4"

Strike

- Standard - Full Lipped Strike
- Option - T-Strike

Door Thickness

- Standard (interior) - 1 3/8" and 1 3/4"
- Standard (entry) - 1 3/4"
- Options - Up to 2 1/2"

Your Ashley Norton distributor can help you specify the correct components for your doors.

Sizes and designs may change without notification. Ashley Norton Inc reserves the right to discontinue products without prior notice.

Ashley Norton

UK Office

Unit 7 Narrowboat Way
Dudley DY2 0XQ
United Kingdom

Toll Free: (800) 565 5625
Fax: (800) 645 5625

US Office

210 West Parkway Suite 1
Pompton Plains, NJ 07444
United States

Tel: (973) 835 4027
Toll Free: (800) 393 1097
Fax: (800) 393 1098

www.ashleynorton.com
info@ashleynorton.com